

**Sanpress Inox G-Bogen 45°
mit SC-Contur**

- Pressanschlüsse

Ausstattung

Dichtelemente HNBR

Modell 0226

Artikel 486 129

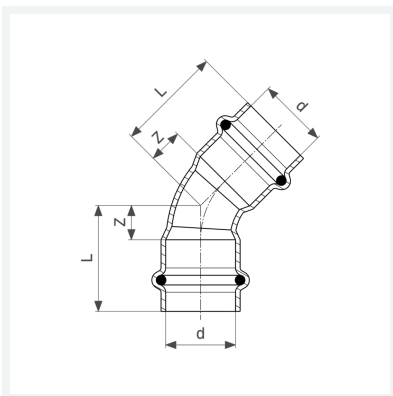

Eigenschaften

Rohraußendurchmesser	d	15
Z-Maß	Z	7 mm
Länge	L	29 mm
Gewicht	37 g	
Volumen	124,32 cm ³	
Werkstoff	Stahl nichtrostend	