

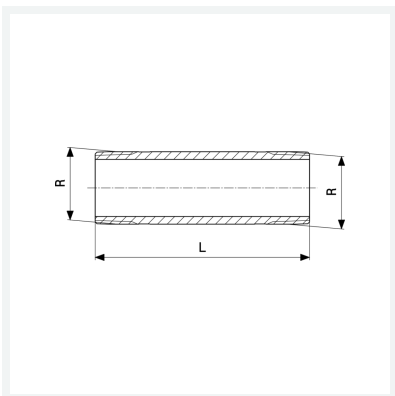

Langnippel
- R-Gewinde
Modell 3530

Artikel 282 417



Eigenschaften

Länge	L	60
Außengewinde kegelig	R	$\frac{3}{8}$
Länge	L	60 mm
Gewicht	70,7 g	
Volumen	49,728 cm ³	
Werkstoff	Rotguss oder Siliziumbronze	