

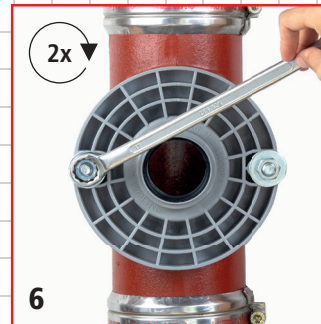

Weil's einfacher geht!

Airfit

Montageanleitung Flansch-Adapter Beispielhaft

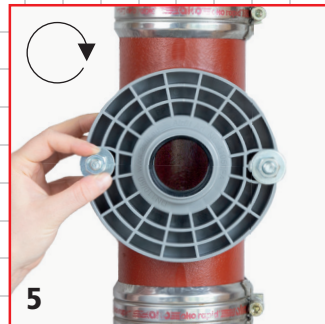
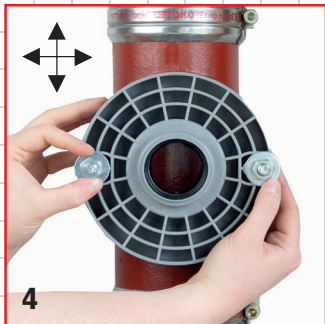
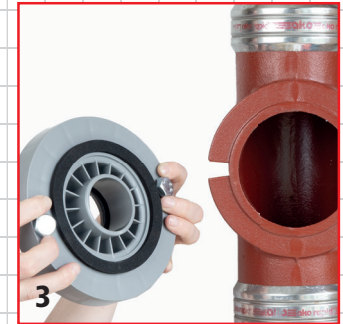
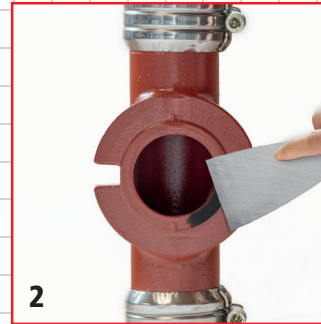
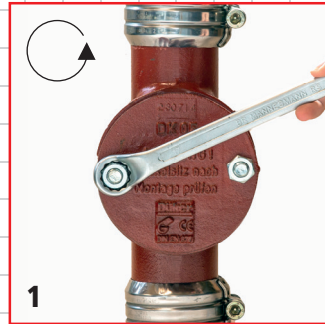
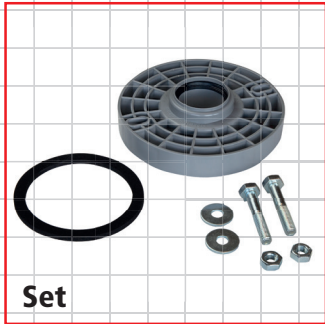

Airfit GmbH & Co. KG Gewerbegebiet Zingsheim-Süd 40 53947 Nettersheim

Tel.: +49 (0) 2486 / 33896 – 0 | Fax: +49 (0) 2486 / 33896 – 29 | www.airfit.eu | post@airfit.eu

Weil's einfacher geht!

Airfit

Flansch-Adapter DN 50/40 aus PP

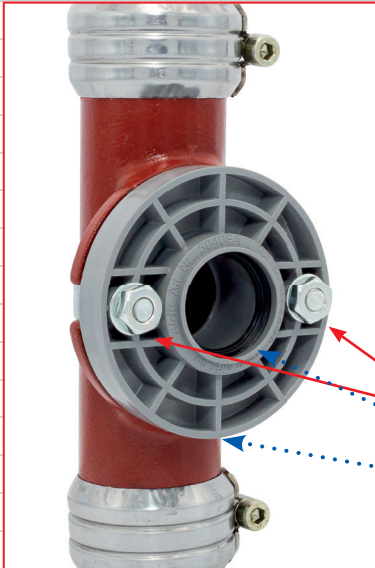

Lochabstand 77 - 83 mm

DN 40

DN 50

Art. Nr. 5040FA



Weitere Größen:

DN 75/50

Art. Nr. 7550FA

DN 110/50

Art. Nr. 11050FA

DN 110/75

Art. Nr. 11175FA

DN 110/90

Art. Nr. 11090FA

DN 110/110

Art. Nr. 119110FA

Alle Flansch-Adapter passen auch auf die alten schwarzen Gussrohre (GA-Rohre)

Aus PP, Brandverhalten: Geprüft nach DIN 4102-B2, EN 13501-1-E, EN 11925-2, Wasserdicht: 3 m WS