











33 816 875



- Ausladung 241 mm
- schwenkbarer Auslauf 360°
- luftangereicherter Strahl
- Armaturenhöhe 393 mm
- Höhe bis Luftsprudler 240 mm
- Bohrungsdurchmesser 35 mm
- 2x US Druckschlauch 3/8"
- Durchfluss max. 8 l/min bei 3 bar Fließdruck
- bleifrei
- Dieses Produkt leistet einen Beitrag zur Erfüllung der Vorgaben von nachhaltigen Gebäudezertifizierungen, z.B. LEED®, BREEAM®, DGNB

	Chrom	33 816 875-00
	Platin gebürstet	33 816 875-06
	Platin	33 816 875-08
	Messing (23kt Gold)	33 816 875-09
	Dark Chrome	33 816 875-19
	Messing gebürstet (23kt Gold)	33 816 875-28
	Schwarz matt	33 816 875-33
	Champagne gebürstet (22kt Gold)	33 816 875-46
	Champagne (22kt Gold)	33 816 875-47
	Chrom gebürstet (Edelstahl-Look)	33 816 875-93
	Dark Platinum gebürstet	33 816 875-99

Empfohlenes Zubehör

Exzenterbetätigung mit Drehknopf - Chrom 10 712 970-00



Empfohlenes Zubehör

Spender ohne Rosette - Chrom 82 424 970-00



33 816 875

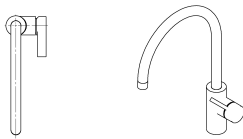
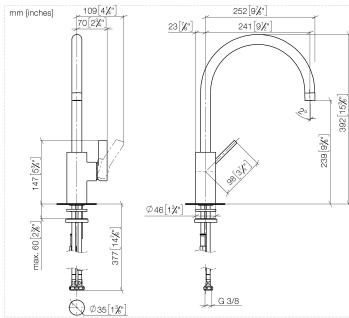

Durchflussdiagramm

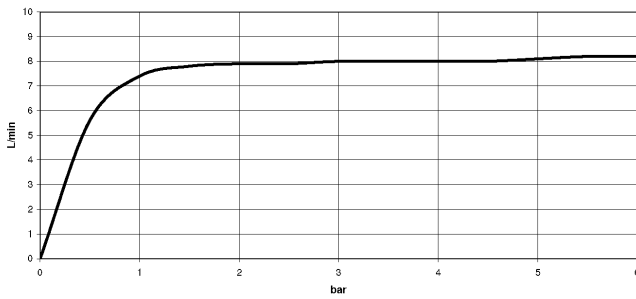

Codes & Standards

DIN 4109

EN 817

Executive Order
no. 1007

ISO 3822

Scottish Water
Byelaws

UK Water Supply
Regulations

Ü-Zeichen

VA-Zeichen



TARA ULTRA Einhebelmischer - Chrom

TARA ULTRA

33 816 875

Zertifikate

LGA_18

GDV_0400

WRAS_2101

ETA_18

33 816 875

Produktversion von 5/31/2010 bis 7/25/2018

Produktversion von 7/25/2018 bis 5/15/2020

Produktversion von 5/15/2020 bis 10/27/2020

Produktversion von 10/27/2020 bis 5/3/2021

Produktversion ab 5/3/2021

Produktversion ab 6/1/2022

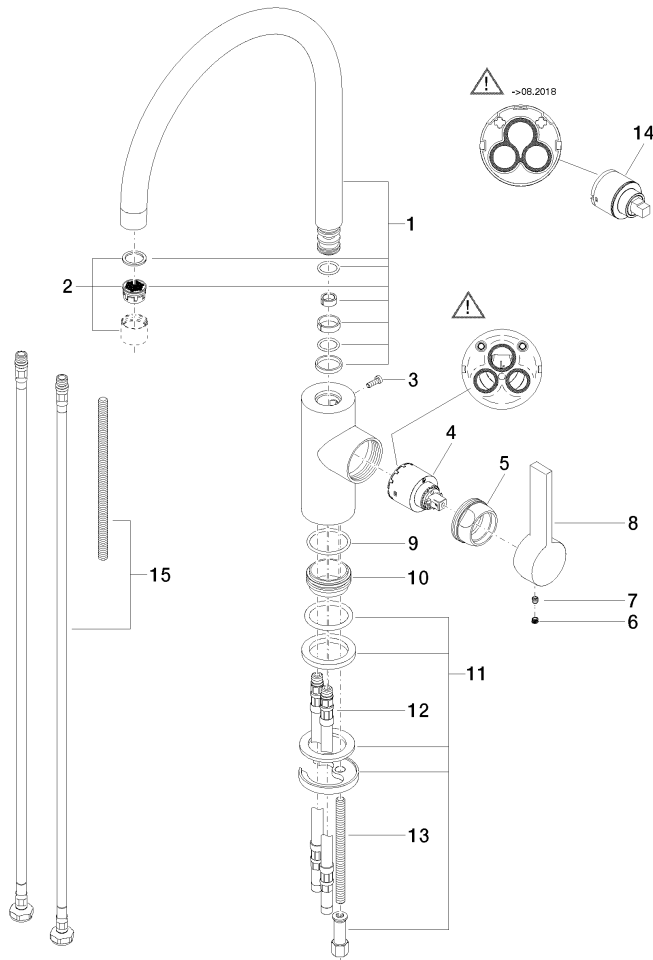



33 816 875

Ersatzteilstückliste

Produktversion von 5/31/2010 bis 7/25/2018

Produktversion von 7/25/2018 bis 5/15/2020

Produktversion von 5/15/2020 bis 10/27/2020

Produktversion von 10/27/2020 bis 5/3/2021

Produktversion ab 5/3/2021

Produktversion ab 6/1/2022

Nr.	Artikelnummer	Benennung	Verbaumenge	Lieferzeit
	90 28 22 202 02-00	Auslauf 240 mm, 8 l/min. - Chrom	16	10