

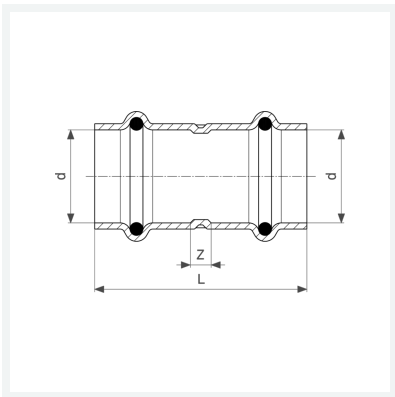

**Profipress G-Muffe
mit SC-Contur**
- Pressanschlüsse
Ausstattung
Dichtelemente HNBR
Modell 2615

Artikel 346 539



Eigenschaften

Rohraußendurchmesser	d	42
Z-Maß	Z	4 mm
Länge	L	76 mm
Gewicht	224,9 g	
Volumen	621,6 cm ³	
Werkstoff	Kupfer	