

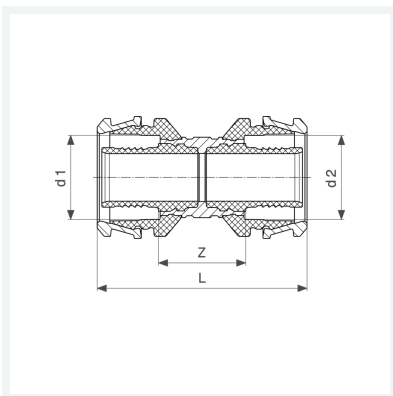

**Raxofix-Kupplung
mit SC-Contur**
- Pressanschluss
Modell 5315

Artikel 646 868



Eigenschaften

Rohraußendurchmesser 1	d1	32
Rohraußendurchmesser 2	d2	32
Z-Maß	Z	25 mm
Länge	L	64 mm
Gewicht	164,9 g	
Volumen	248,64 cm ³	
Werkstoff	Siliziumbronze	