



Profipress-Schiebemuffe mit SC-Contur

- Pressanschlüsse

Ausstattung

Dichtelemente EPDM

Modell 2415.3

Artikel 461 294

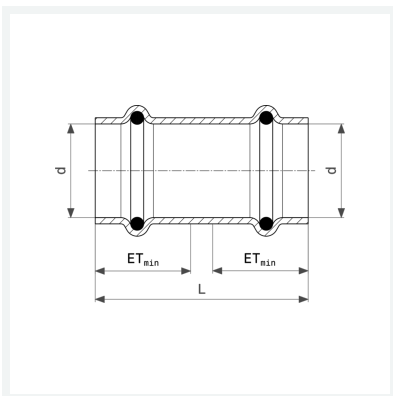

Eigenschaften

Rohraußendurchmesser	d	35
Länge	L	56 mm
Einstecktiefe minimal	ETmin	26 mm
Gewicht	98 g	
Volumen	207,2 cm ³	
Werkstoff	Kupfer	