

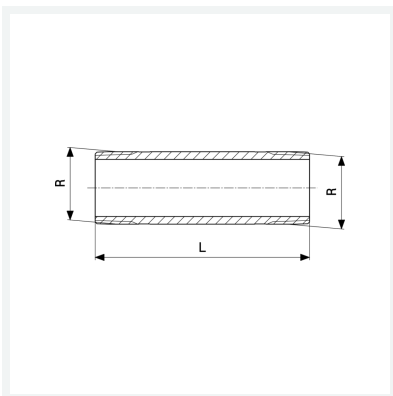

Langnippel
- R-Gewinde
Modell 3530

Artikel 318 482



Eigenschaften

Länge	L	60
Außengewinde kegelig	R	1¼
Länge	L	60 mm
Gewicht	221,3 g	
Volumen	248,64 cm ³	
Werkstoff	Rotguss oder Siliziumbronze	