

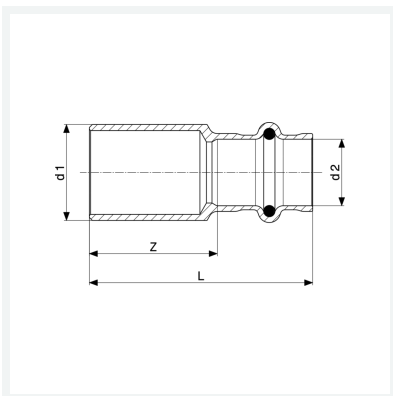

**Sanpress-Muffe
mit SC-Contur**
- Pressanschlüsse
Ausstattung
Dichtelemente EPDM
Modell 2215

Artikel 116 835



Eigenschaften

Rohraußendurchmesser	d	42
Z-Maß	Z	4 mm
Länge	L	76 mm
Gewicht	195,5 g	
Volumen	414,4 cm ³	
Werkstoff	Rotguss oder Siliziumbronze	