

CL.1 Seitenventil linksschließend warm - Dark Platinum gebürstet







CL.1

20 000 706

- Bohrungsdurchmesser Seitenventil 32 mm
- Rosette 60 x 60 mm
- mit Warmkennzeichnung

Passt zu CL.1



	Dark Platinum gebürstet	20 000 706-99
	Chrom	20 000 706-00
	Platin gebürstet	20 000 706-06
	Dark Chrome	20 000 706-19
	Champagne gebürstet (22kt Gold)	20 000 706-46
	Champagne (22kt Gold)	20 000 706-47

20 000 706

mm [inches]

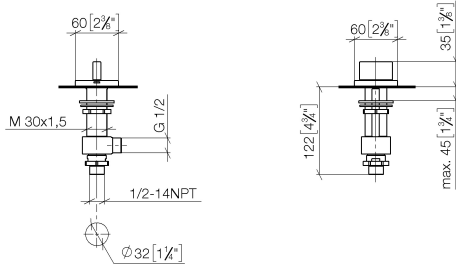

Durchflussdiagramm



Codes & Standards

ASME A112.18.1

cUPC

DIN 4109

ISO 3822

Scottish Water
Byelaws

UK Water Supply
Regulations

Ü-Zeichen



CL.1 Seitenventil linksschließend warm - Dark Platinum gebürstet

CL.1

20 000 706

Zertifikate

IAPMO_4976

WRAS_2103

LGA_28

20 000 706

Produktversion ab 3/9/2015

Ersatzteile für die
anderen
Oberflächenvarianten
finden Sie hier:
Chrom

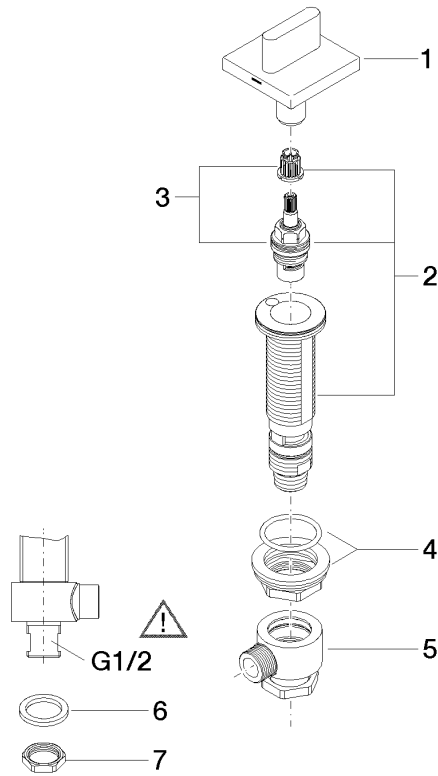



CL.1 Seitenventil linksschließend warm - Dark Platinum gebürstet

CL.1

20 000 706

Ersatzteilstückliste

Produktversion ab 3/9/2015

Nr.	Artikelnummer	Benennung	Verbaumenge	Lieferzeit
	90 20 70 051 05-99	Griff für Wanne Hot oval pur 60 x 60 x 40 mm - Dark Platinum gebürstet	8	30