

Seitenventil rechtsschließend warm - Dark Platinum gebürstet

CL.1







20 000 715



- Bohrungsdurchmesser 32 mm
- Rosette 60 x 60 mm
- mit Warmkennzeichnung

Passt zu CL.1

Passt zu: CL.1, CYO

	Dark Platinum gebürstet	20 000 715-99
	Chrom	20 000 715-00
	Platin gebürstet	20 000 715-06
	Dark Chrome	20 000 715-19
	Messing gebürstet (23kt Gold)	20 000 715-28
	Champagne gebürstet (22kt Gold)	20 000 715-46
	Champagne (22kt Gold)	20 000 715-47

20 000 715

mm [inches]

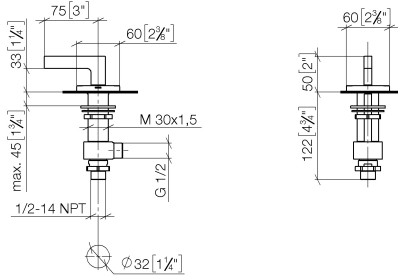

Durchflussdiagramm



Codes & Standards

ASME A112.18.1

cUPC

DIN 4109

ISO 3822

Ü-Zeichen



Seitenventil rechtsschließend warm - Dark Platinum gebürstet

CL.1

20 000 715

Zertifikate

IAPMO_4976

LGA_28

20 000 715

Produktversion ab 6/1/2015

Ersatzteile für die
anderen
Oberflächenvarianten
finden Sie hier:
Chrom

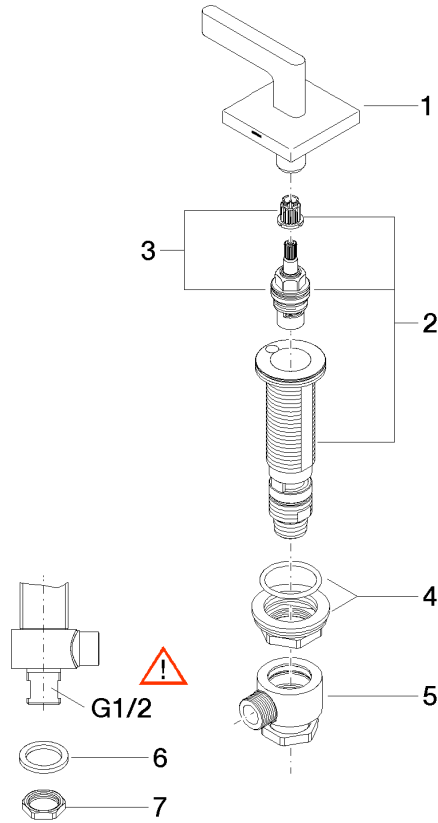



Seitenventil rechtsschließend warm - Dark Platinum gebürstet

CL.1

20 000 715

Ersatzteilstückliste

Produktversion ab 6/1/2015

Nr.	Artikelnummer	Benennung	Verbaumenge	Lieferzeit
	90 20 70 057 00-99	Griff für Wanne Hot Hebel 60 x 60 x 40 mm - Dark Platinum gebürstet	7	30