

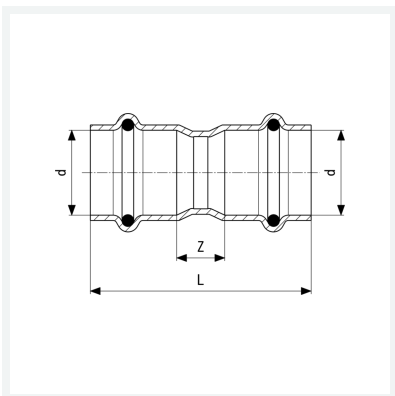

**Temponox-Muffe
mit SC-Contur**
- Pressanschlüsse
Ausstattung
Dichtelemente EPDM
Modell 1715

Artikel 809 065



Eigenschaften

Rohraußendurchmesser	d	15
Z-Maß	Z	12 mm
Länge	L	56 mm
Gewicht	37 g	
Volumen	62,16 cm ³	
Werkstoff	Stahl nichtrostend	