

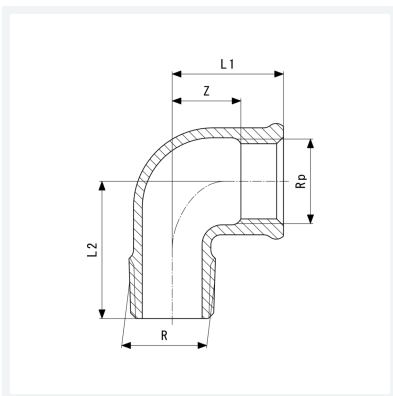

Bogen 90°
- R-Gewinde, Rp-Gewinde
Modell 3092

Artikel 264 123



Eigenschaften

Außengewinde kegelig	R	1½
Innengewinde zylindrisch	Rp	1½
Z-Maß	Z	39 mm
Länge 1	L1	60 mm
Länge 2	L2	59 mm
Gewicht	416 g	
Volumen	621,6 cm ³	
Werkstoff	Rotguss oder Siliziumbronze	