

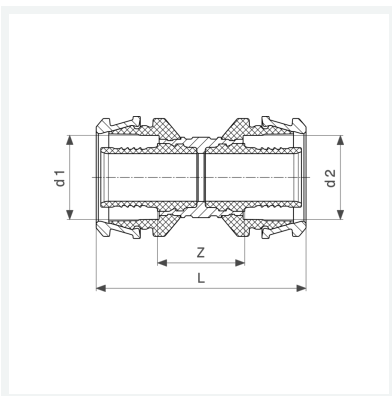

**Raxofix-Kupplung
mit SC-Contur**
- Pressanschluss
Modell 5315

Artikel 646 899



Eigenschaften

Rohraußendurchmesser 1	d1	40
Rohraußendurchmesser 2	d2	40
Z-Maß	Z	31 mm
Länge	L	83 mm
Gewicht	315,2 g	
Volumen	621,6 cm ³	
Werkstoff	Siliziumbronze	