

Weil's einfacher geht!

Airfit

Schlauchkupplung und -nippel aus PP, heißwasserbeständig bei 90°C

NEU!

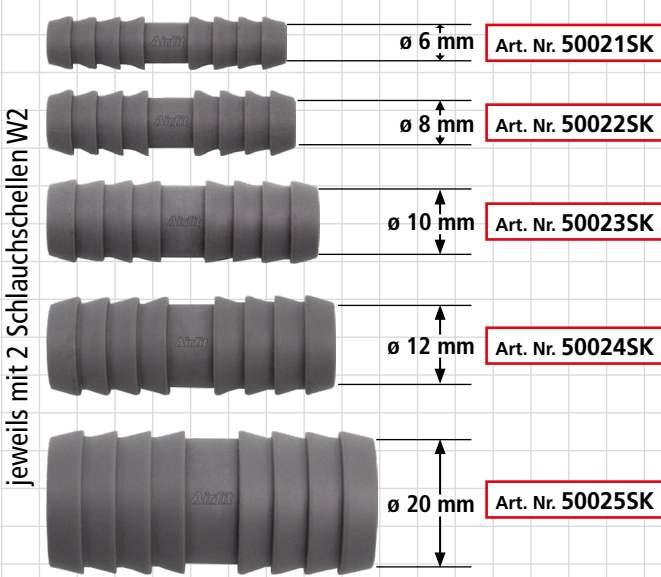

Universal - Schlauchkupplung
Beidseitig ø 8,4 - 26,5 mm

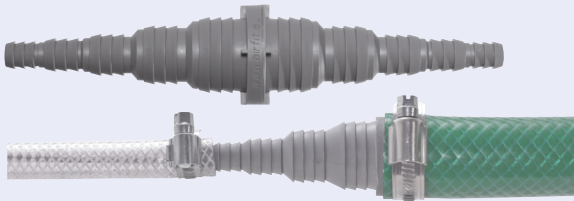

Art. Nr. 50014SK

- optimale Verbindung von unterschiedlichen Schlauchgrößen
- einfach passend abschneiden • aus PP • heißwasserbeständig bis 90°C

Schlauchnippel Universal aus PVC

3/4" AG 8,3-26,5 mm, PN2 60°C

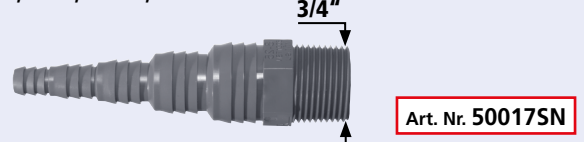

Pumpennippel Universal aus PVC

3/4", 1", 1 1/4" AG 8,3-33,5 mm, PN2 60°C

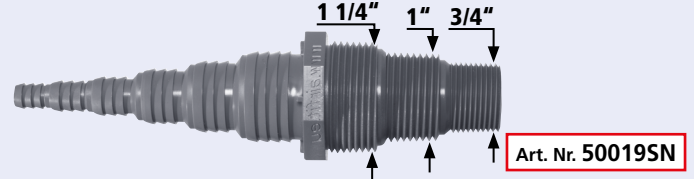

Optimaler Doppel-Anschlusswinkel für Waschmaschine und Kondensattrockner aus PP, heißwasserbeständig bis 90 °C

NEU!

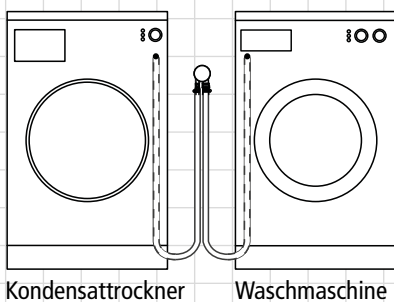

Art. Nr. 50042WTW



Art. Nr. 50052WTW

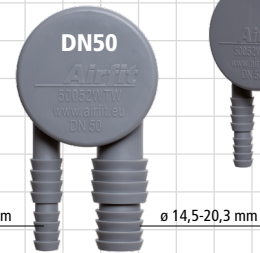

Mit den durchhängenden Schläuchen ist kein Siphon mehr erforderlich

Rückflussverhinderer-Set für Kondensattrockner

NEU!

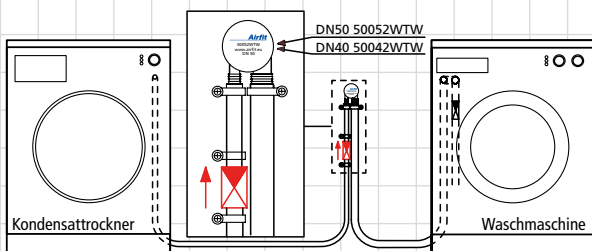

Set bestehend aus:

Art. Nr. 50060WTW

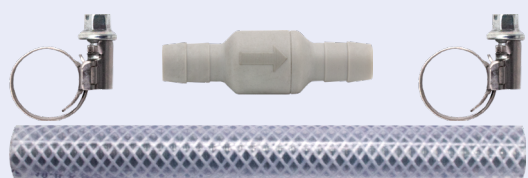

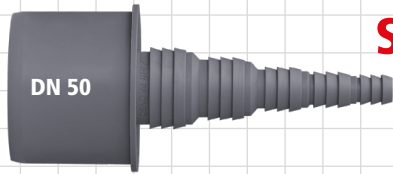

Schlauchnippel aus PP

- heißwasserbeständig bis 90 °C
- Brandverhalten: Geprüft nach DIN 4102-B2, EN 13501-1E, EN 11925-2.

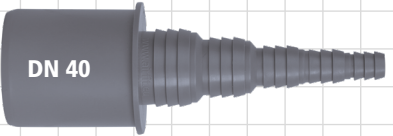

DN 50 8,2-26,5 mm Art. Nr. 50011SN



DN 40 8,2-26,5 mm Art. Nr. 50013SN

DN 32 8,5-26,5 mm Art. Nr. 50015SN

Kondensat-Set



Art. Nr. 50012KS

Doppel-Schlauchnippel aus PP

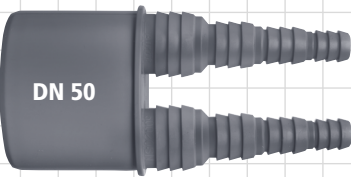

- heißwasserbeständig bis 90 °C
- Brandverhalten: Geprüft nach DIN 4102-B2, EN 13501-1E, EN 11925-2.

DN 50 8,3-20,5 mm Art. Nr. 50020SN

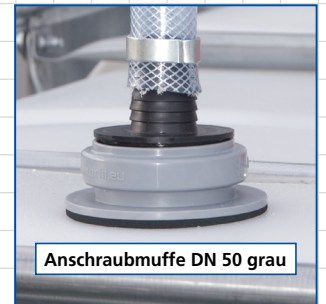

Anschraubmuffe DN 50 grau

Schlauchwinkel aus PP



DN 40
18-21,7 mm
Art. Nr. 50040SW



DN 50
18-21,7 mm
Art. Nr. 50010SW

- heißwasserbeständig bis 90 °C
- Brandverhalten: Geprüft nach DIN 4102-B2, EN 13501-1E, EN 11925-2.



Wasch- und Spülmaschinen



DN 32
8,5-26,6 mm
Art. Nr. 50003SW

NEU!



DN 40
8,5-26,6 mm
Art. Nr. 50016SW

NEU!



DN 50
8,5-26,6 mm
Art. Nr. 50005SW

Pumpenwinkel Universal aus PVC

1 1/4" AG, 8,3-33,5 mm, PN2 60°C

Art. Nr. 50018SW

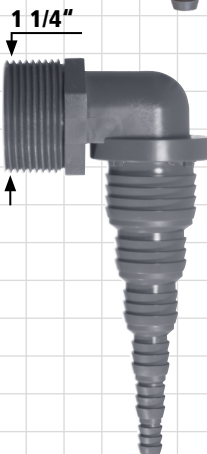

Einfach passend abschneiden:



Optimaler Übergang vom Schlauch zum Abflussrohr.

