

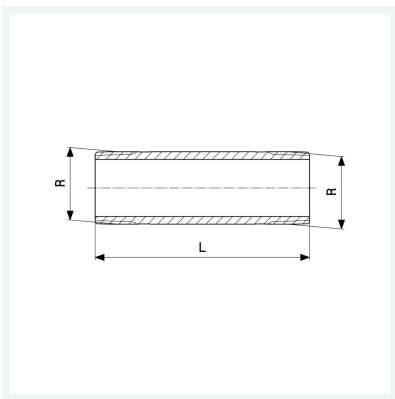

Langnippel
- R-Gewinde
Modell 3530

Artikel 267 247



Eigenschaften

Länge	L	40
Außengewinde kegelig	R	1
Länge	L	40 mm
Gewicht	98,91 g	
Volumen	124,32 cm ³	
Werkstoff	Rotguss oder Siliziumbronze	