

STEINBERG



Waschtisch-Einhebelmischbatterie

Art.Nr.160 1700

Installation

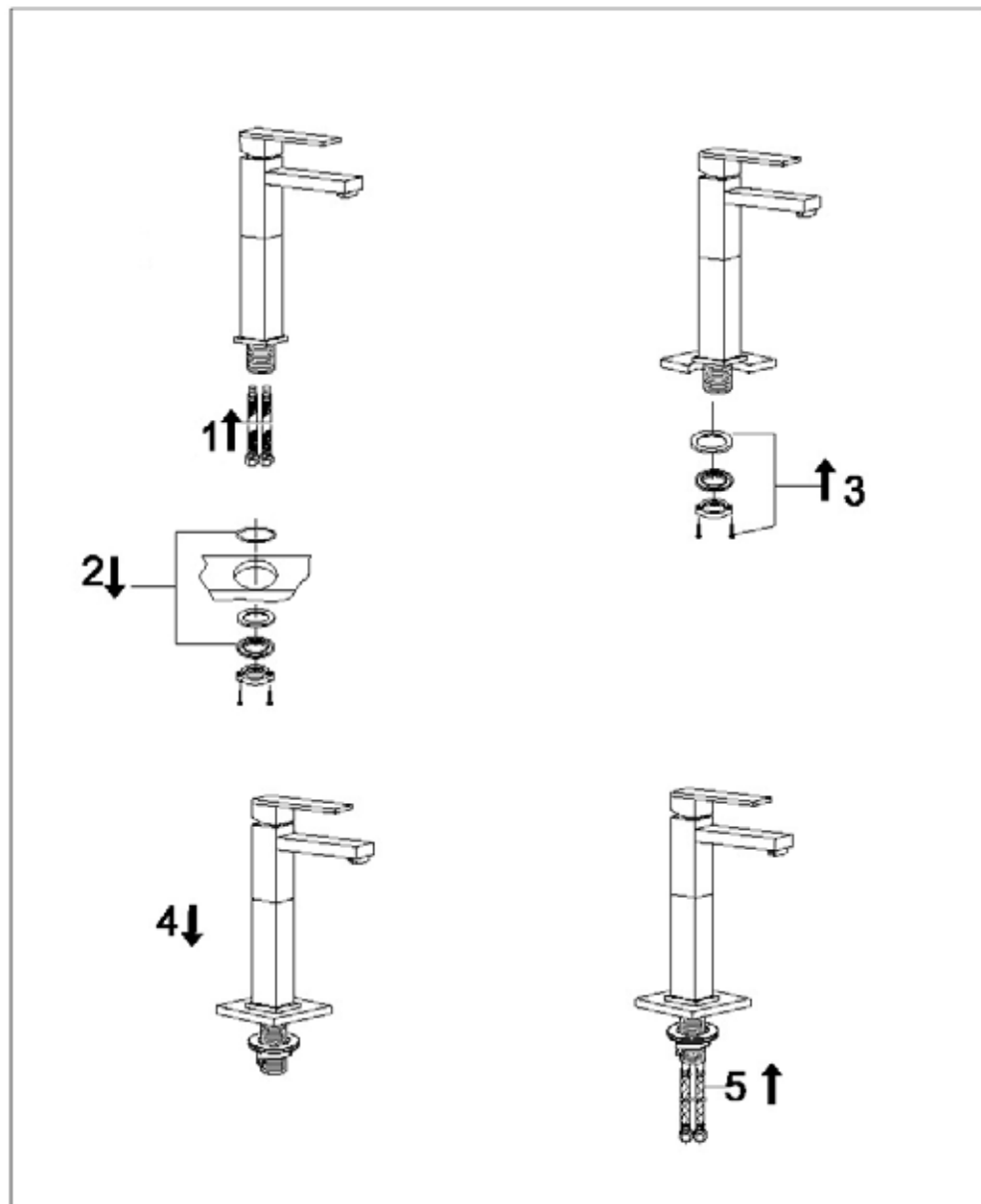

Technische Zeichnung

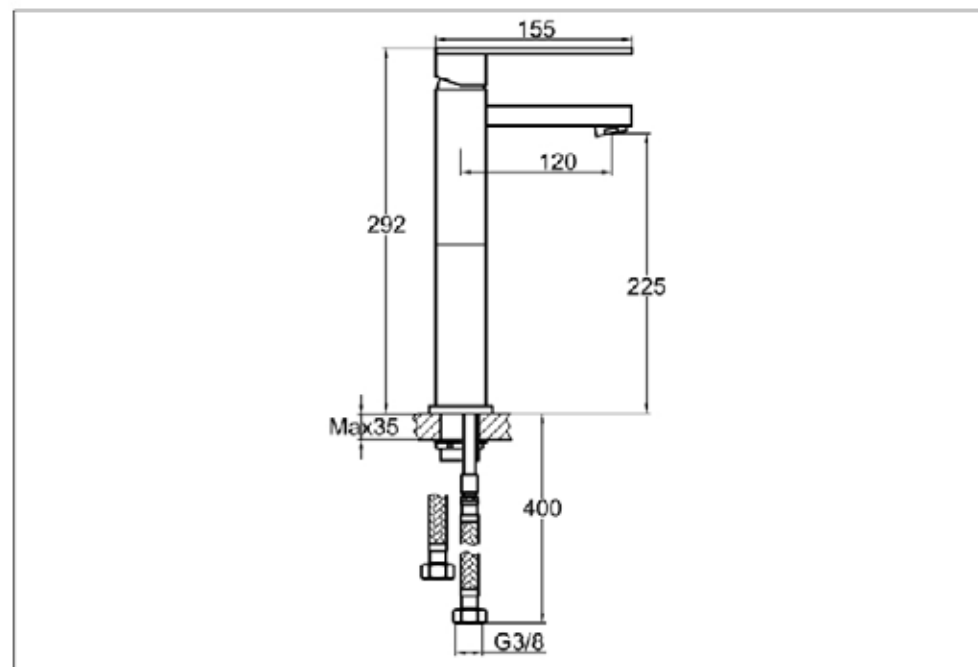

Explosionszeichnung

