

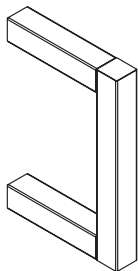

- Ⓓ **Montageanleitung**
- ⒼⒷ **Installation instructions**
- Ⓕ **Montage**
- ⒼⓁ **Montage van**
- Ⓘ **Istruzioni di montaggio**
- Ⓔ **Montaje instrucciones**
- ⒴ **Instrukcja montażu**



100.03.01040/100.03.01060

Haltegriff  
Support rail  
Barre de maintien  
Wandstein  
Impugnatura di sicurezza  
Asidero  
Uchwyt

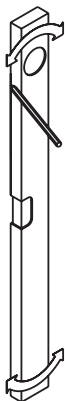

1

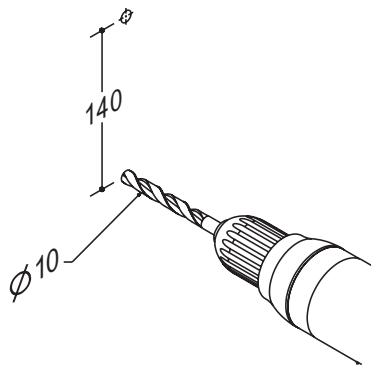

2

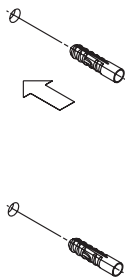

3

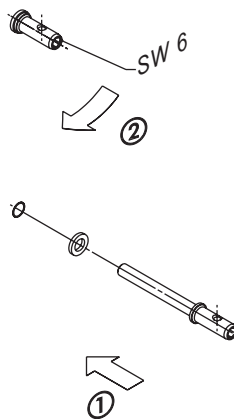

4

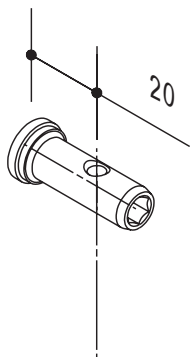

5

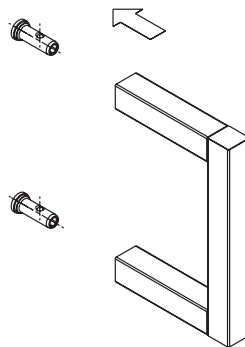

6

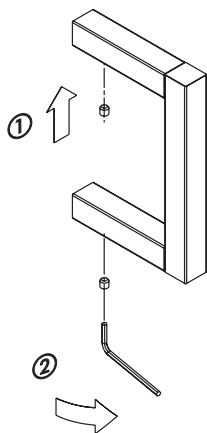

7

8

# HEWI

[www.hewi.com](http://www.hewi.com)

## Deutschland

HEWI Heinrich Wilke GmbH

Postfach 1260

D-34442 Bad Arolsen

Telefon: +49 5691 82-0

Telefax: +49 5691 82-319

[info@hewi.de](mailto:info@hewi.de)

[www.hewi.de](http://www.hewi.de)