





22 513 892



- Ausladung 165 mm
- Ablaufgarnitur 1 1/4"
- schwenkbarer Auslauf 360°
- runder luftangereicherter Strahl
- Armaturenhöhe 295 mm
- Höhe bis Luftsprudler 172 mm
- Bohrungsdurchmesser 35 mm
- Rosette Ø 59 mm
- 2x Druckschlauch M 10 x 1 eingeschraubt, dichtheitsgeprüft
- 2x US Druckschlauch 3/8"
- Durchfluss max. 7 l/min
- bleifrei
- Dieses Produkt leistet einen Beitrag zur Erfüllung der Vorgaben von nachhaltigen Gebäudezertifizierungen, z.B. LEED®, BREEAM®, DGNB

Nur für Becken mit Überlauf geeignet.

	Dark Platinum gebürstet	22 513 892-99
	Chrom	22 513 892-00
	Platin gebürstet	22 513 892-06
	Platin	22 513 892-08
	Dark Chrome	22 513 892-19
	Light Gold gebürstet	22 513 892-27
	Messing gebürstet (23kt Gold)	22 513 892-28
	Schwarz matt	22 513 892-33
	Bronze gebürstet	22 513 892-42
	Champagne gebürstet (22kt Gold)	22 513 892-46
	Champagne (22kt Gold)	22 513 892-47
	Chrom gebürstet	22 513 892-93

22 513 892

mm [inches]

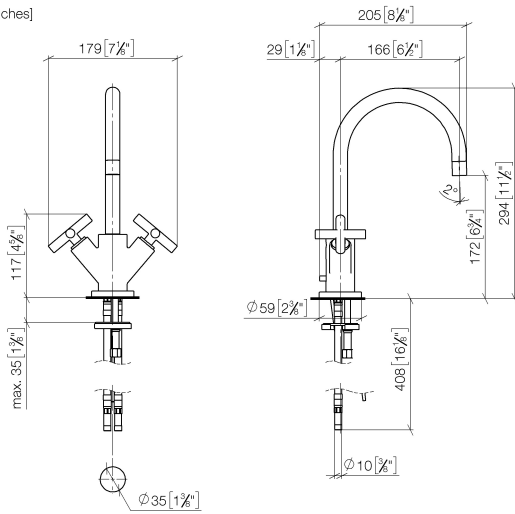

Durchflussdiagramm

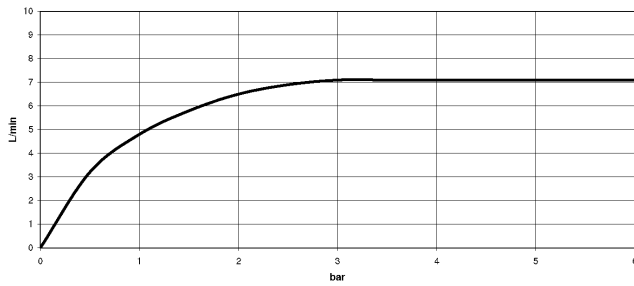

Codes & Standards

DIN 4109	EN 200	Executive Order no. 1007	ISO 3822
Scottish Water Byelaws	UK Water Supply Regulations	Ü-Zeichen	VA-Zeichen



TARA Waschtisch-Einlochbatterie mit Ablaufgarnitur - Dark Platinum gebürstet

TARA

22 513 892

Zertifikate

GDV_0400

LGA_18

ETA_18

WRAS_1810

22 513 892

Produktversion von 6/30/2009 bis 5/27/2021

Ersatzteile für die
anderen
Oberflächenvarianten
finden Sie hier:
Chrom

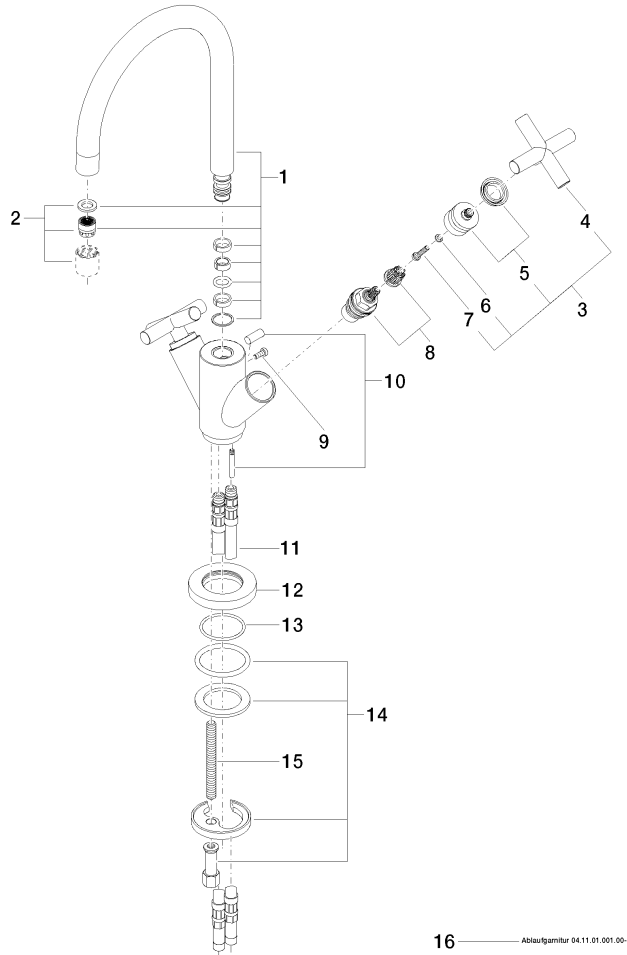



TARA Waschtisch-Einlochbatterie mit Ablaufgarnitur - Dark Platinum gebürstet

TARA

22 513 892

Ersatzteilstückliste

Produktversion von 6/30/2009 bis 5/27/2021

Nr.	Artikelnummer	Benennung	Verbaumenge	Lieferzeit
	90 28 22 213 01-99	Auslauf 165 mm, 7 l/min. - Dark Platinum gebürstet	23	30