

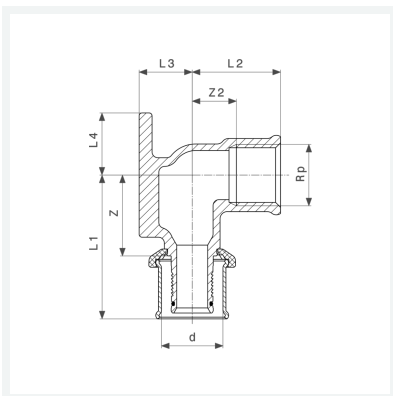

**Sanfix P-Wandscheibe  
mit SC-Contur**

- Pressanschluss, Rp-Gewinde  
**Modell 2125.5**

**Artikel 303 181**



## Eigenschaften

Rohraußendurchmesser	d	16
Innengewinde zylindrisch	Rp	½
Z-Maß 1	Z1	22 mm
Z-Maß 2	Z2	21 mm
Länge 1	L1	42 mm
Länge 2	L2	30 mm
Länge 3	L3	16 mm
Länge 4	L4	19 mm
Gewicht	129,8 g	
Volumen	207,2 cm <sup>3</sup>	

# Datenblatt



**Sanfix P-Wandscheibe  
mit SC-Contur  
Modell 2125.5  
Artikel 303 181**

## Eigenschaften

---

Werkstoff

Rotguss