







13 801 845



- Ausladung 210 mm
- runder Normalstrahl
- Bohrungsdurchmesser 37 mm
- Anschluss 1/2"
- Steckanschluss-Montage
- Durchfluss max. 21,5 l/min bei 3 bar Fließdruck

	Chrom	13 801 845-00
	Platin gebürstet	13 801 845-06
	Dark Chrome	13 801 845-19
	Light Gold gebürstet	13 801 845-27
	Schwarz matt	13 801 845-33
	Chrom gebürstet	13 801 845-93
	Dark Platinum gebürstet	13 801 845-99

Empfohlenes Zubehör



- UP-Wandwinkel -** 35 085 970 90
- Max. Einbautiefe 163 mm
 - Min. Einbautiefe 90 mm

13 801 845

mm [inches]

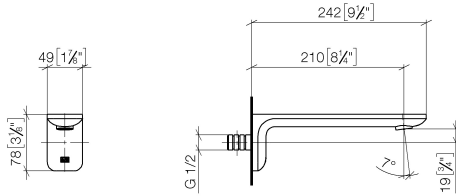

Durchflussdiagramm

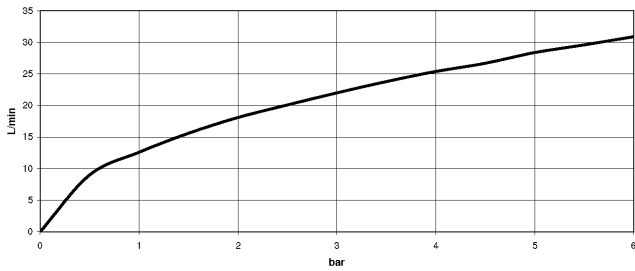

Codes & Standards

ASME A112.18.1

cUPC

DIN 4109

ISO 3822

Scottish Water
Byelaws

UK Water Supply
Regulations

Ü-Zeichen



LISSÉ Wannenauslauf für Wandmontage - Chrom

LISSÉ

13 801 845

Zertifikate

WRAS_2207

LGA_29

IAPMO_4976

Produktversion ab 3/9/2016

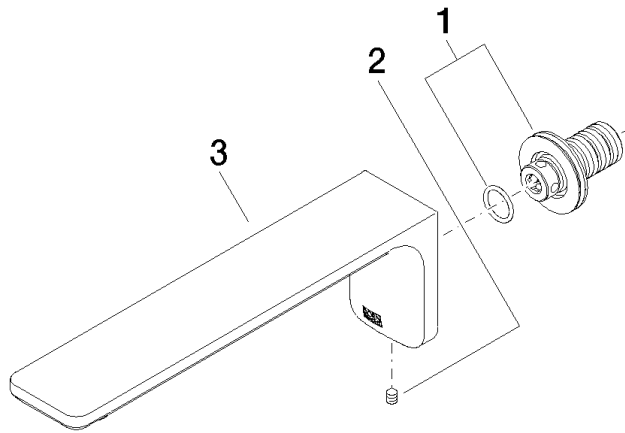



LISSÉ Wannenauslauf für Wandmontage - Chrom

LISSÉ

13 801 845

Ersatzteilstückliste

Produktversion ab 3/9/2016

Nr.	Artikelnummer	Benennung	Verbaumenge	Lieferzeit
	90 24 03 108 00 90	Nippel Ø 40 x 50 mm, 5 l/min. -	3	2