

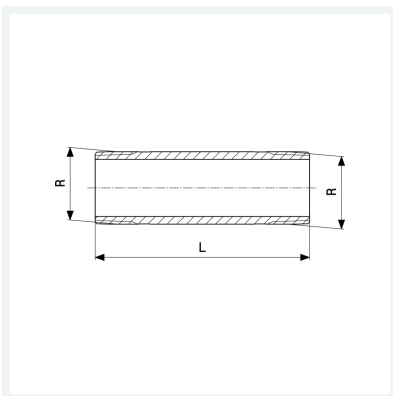

Langnippel
- R-Gewinde
Modell 3530

Artikel 267 384



Eigenschaften

Länge	L	40
Außengewinde kegelig	R	¾
Länge	L	40 mm
Gewicht	71,7 g	
Volumen	62,16 cm ³	
Werkstoff	Rotguss oder Siliziumbronze	