

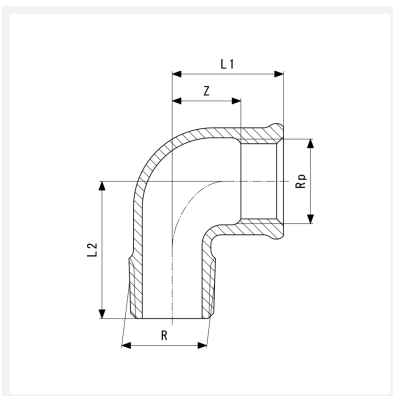

**Bogen 90°**  
- R-Gewinde, Rp-Gewinde  
**Modell 3092**

**Artikel 264 147**



## Eigenschaften

Außengewinde kegelig	R	2
Innengewinde zylindrisch	Rp	2
Z-Maß	Z	32 mm
Länge 1	L1	58 mm
Länge 2	L2	79 mm
Gewicht	682 g	
Volumen	1243,2 cm <sup>3</sup>	
Werkstoff	Rotguss oder Siliziumbronze	