











33 800 888



- Ausladung 201 mm
- schwenkbarer Auslauf 360°
- luftangereicherter Strahl
- Armaturenhöhe 325 mm
- Höhe bis Luftsprudler 180 mm
- Bohrungsdurchmesser 35 mm
- 2x US Druckschlauch 3/8"
- Durchfluss max. 7 l/min bei 3 bar Fließdruck
- bleifrei
- Dieses Produkt leistet einen Beitrag zur Erfüllung der Vorgaben von nachhaltigen Gebäudezertifizierungen, z.B. LEED®, BREEAM®, DGNB

	Chrom	33 800 888-00
	Platin gebürstet	33 800 888-06
	Platin	33 800 888-08
	Messing (23kt Gold)	33 800 888-09
	Dark Chrome	33 800 888-19
	Messing gebürstet (23kt Gold)	33 800 888-28
	Schwarz matt	33 800 888-33
	Champagne gebürstet (22kt Gold)	33 800 888-46
	Champagne (22kt Gold)	33 800 888-47
	Chrom gebürstet (Edelstahl-Look)	33 800 888-93
	Dark Platinum gebürstet	33 800 888-99

Empfohlenes Zubehör

Exzenterbetätigung mit Drehknopf - Chrom 10 710 970-00



Empfohlenes Zubehör

Spender mit Rosette - Chrom 82 444 970-00



33 800 888

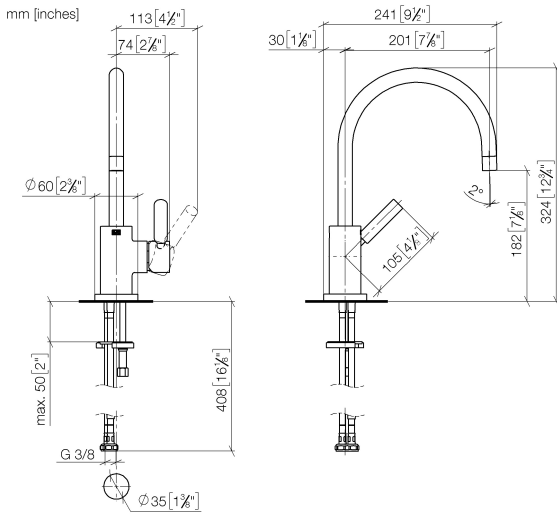

Durchflussdiagramm



Codes & Standards

DIN 4109

EN 817

Executive Order
no. 1007

ISO 3822

Scottish Water
Byelaws

UK Water Supply
Regulations

Ü-Zeichen

VA-Zeichen



TARA Einhebelmischer - Chrom

TARA

33 800 888

Zertifikate

LGA_8

GDV_0400

WRAS_2311

ETA_18

33 800 888

Produktversion bis 5/31/2010

Produktversion von 5/31/2010 bis 10/27/2020

Produktversion von 10/27/2020 bis 9/7/2021

Produktversion ab 9/1/2021

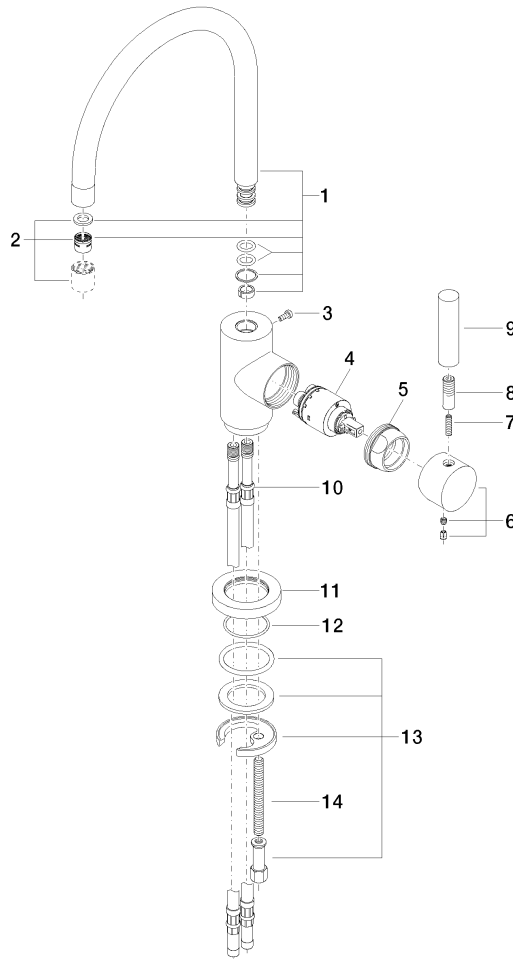



TARA Einhebelmischer - Chrom

TARA

33 800 888

Ersatzteilstückliste

Produktversion bis 5/31/2010

Produktversion von 5/31/2010 bis 10/27/2020

Produktversion von 10/27/2020 bis 9/7/2021

Produktversion ab 9/1/2021

Nr.	Artikelnummer	Benennung	Verbaumenge	Lieferzeit
	90 28 22 048 00-00	Auslauf 225 x 244 x 25 mm - Chrom	15	10